

Application Note

4

Analog Audio Passive Crossover

Highlights

Importing Transducer Response Data
Importing Transducer Impedance Data
Conjugate Impedance Compensation
Circuit Optimization

■ Design Objective

3-Way Passive Crossover
200Hz/2kHz Crossover Points
4th Order Crossover
Optimized Response
Impedance Compensated Transducers

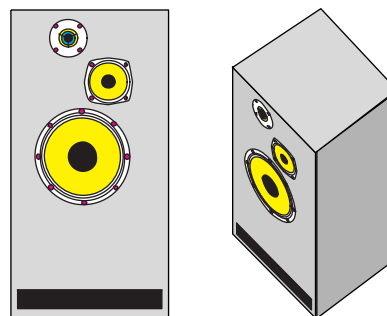

This design will provide an example of how to integrate many of the powerful features in the software, to produce a custom analog passive crossover network.

■ Prototype Data

We will assume that a prototype 3-way enclosure has been constructed, similar to that shown above, and that both SPL and Impedance data has been obtained for each of the three sections: Woofer, Midrange, and Tweeter. This data is measured prior to the use of any crossover, and reflects the response and impedance of each section measured separately.

The six graphs on the following page show the SPL and Impedance for each of the three transducers. Both magnitude and phase is plotted for all six, and a common frequency range of 10Hz to 40kHz is used.

Measured phase data may or may not contain the absolute position (delay) information. In this case it does not. The SPL phase measurements for each of the three transducers are relative to the acoustic origin (voice coil) location. Consequently, we will need to handle the true time position separately.

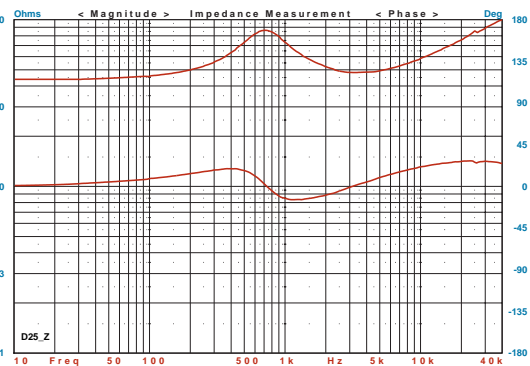
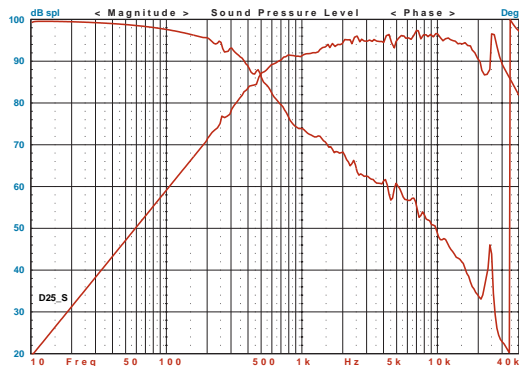
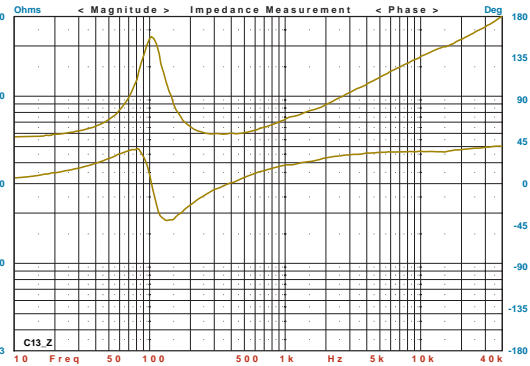
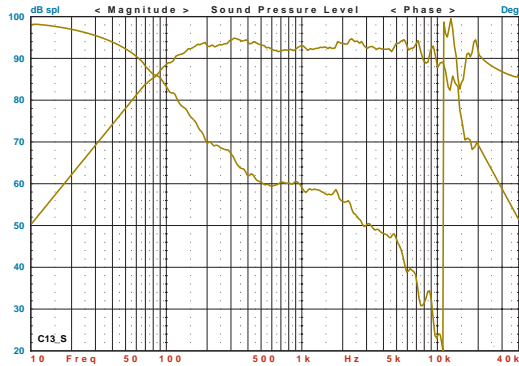
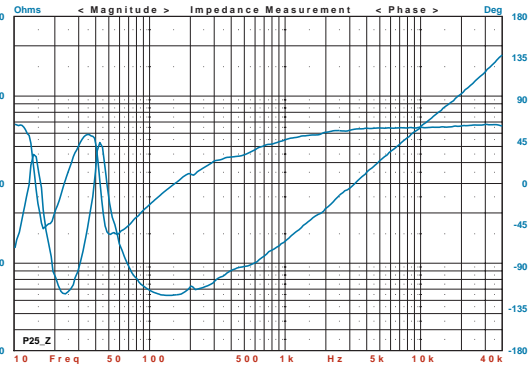
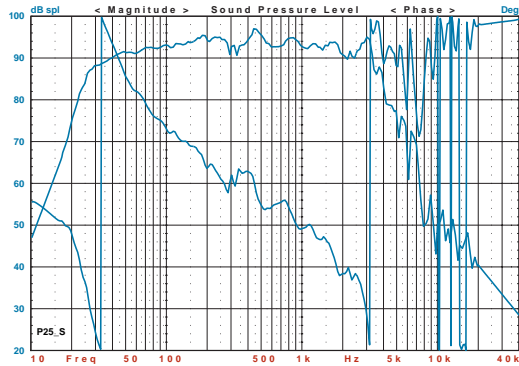

■ Woofer Impedance Compensation

The response of any passive network is directly affected by the loading on the network. Filter networks are generally designed based on a fixed resistive load. Since the impedance of a transducer is highly complex, and certainly not fixed, a common technique is to apply *conjugate compensation*. In this case the reactive components are essentially cancelled by a conjugate network to yield a largely resistive constant impedance.

We start with a circuit consisting of only a Z impedance component and a generator. The woofer impedance is imported into the Z1 component, and the generator V1 is setup for constant 1 Amp current source operation. In this manner the voltage appearing at the terminals of the load will be directly equal to the impedance of the load.

To accomplish this, the generator must have an output impedance much greater than the load. We shall use 1M Ohm. To produce 1 Amp of current, the voltage must also be 1M Volt, or 120dB. The figure below displays the initial circuit setup.

The Magnitude and Amplitude graphs on the following page display the resulting voltage at the Woofer terminal, which is now equal to the impedance of the woofer.

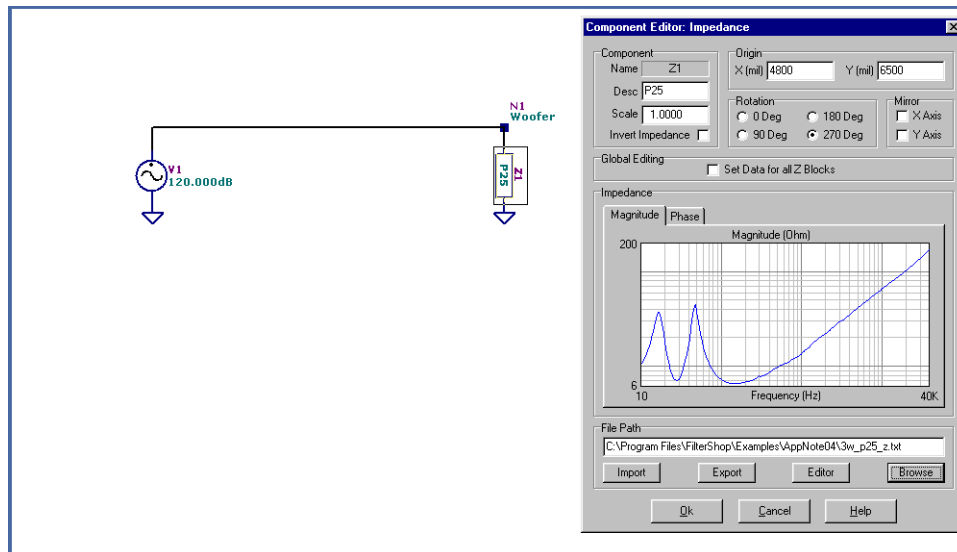

The Magnitude graph displays the equivalent of dB Ohms (1 Ohm = 0 dB), while the Amplitude graph displays linear Ohms.

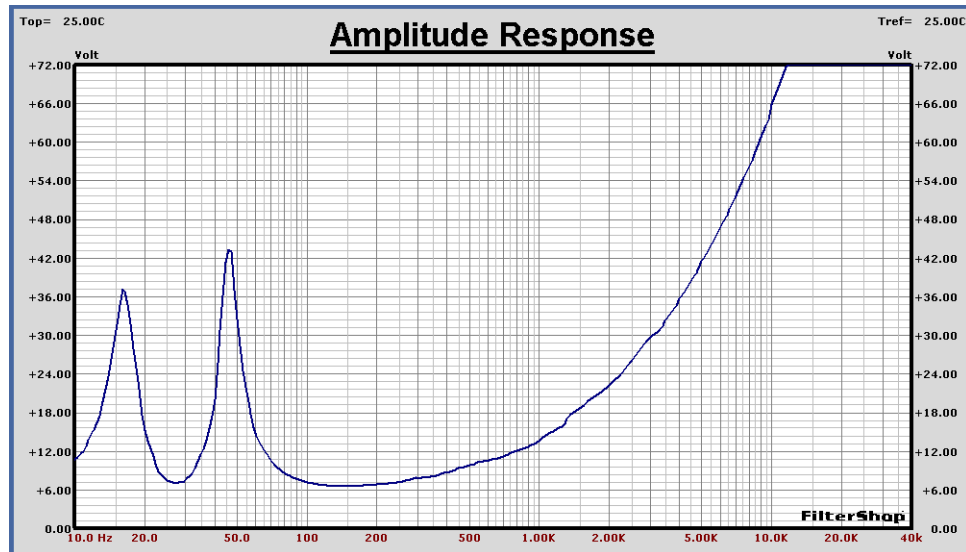
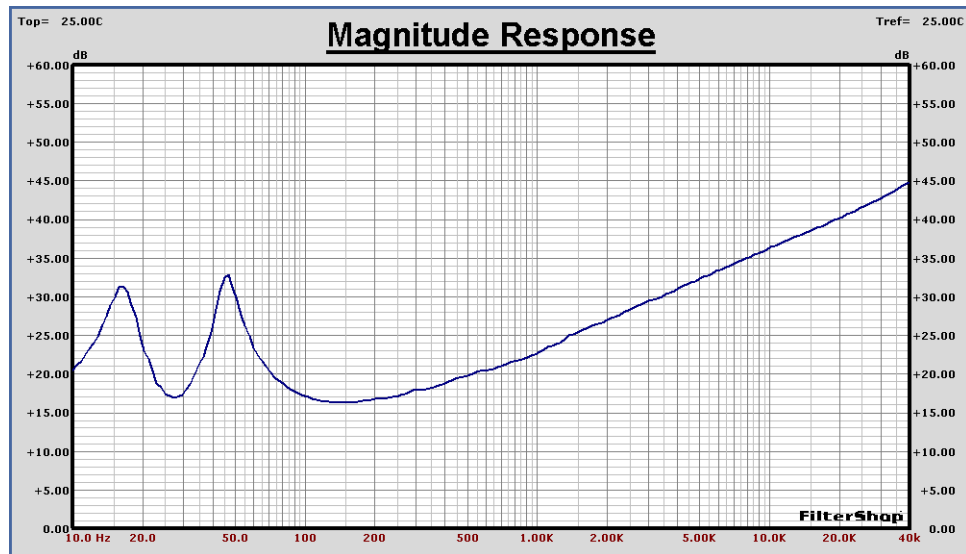

The reactive impedance of the Woofer can be considered in two parts: one part is the inductive rise at high frequencies, and the other is the double hump resonance at low frequencies. To cancel the high frequency rise, a series resistor and capacitor shunting the load will be used.

The RC shunt shown below is initially given the rough arbitrary values of 10 Ohms and 10u Farads. The resulting impedance is shown in the Magnitude graph below. The high frequency rise has been reduced, but it is not optimal.

To optimize the RC network, we must first create an objective in a Guide Curve for the circuit optimizer to use. A flat line is the objective, but at what impedance?

As an initial guess we will simply use the lowest impedance which occurs on the Woofer curve which is about 6.5 Ohms. An empty Target response was used as a flat line, and then scaled to the correct level. This is shown as the gray Guide Curve flat line below.

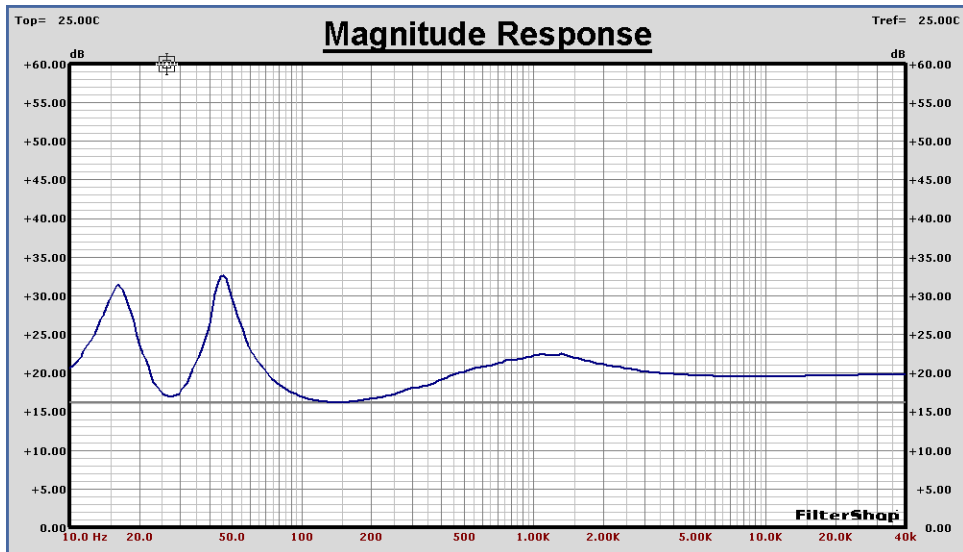

Since the RC network will only be effective on the high frequency rise, we will limit the optimizer frequency range from 150Hz to 40kHz. The RC shunt has no ability to control the double hump problem, and so the optimizer will ignore this region.

Average Error optimization is used, and after the optimizer has finished, the results are shown below. The upper frequency impedance range is now nearly flat. The RC values are 6.8 Ohms and 39u Farads.

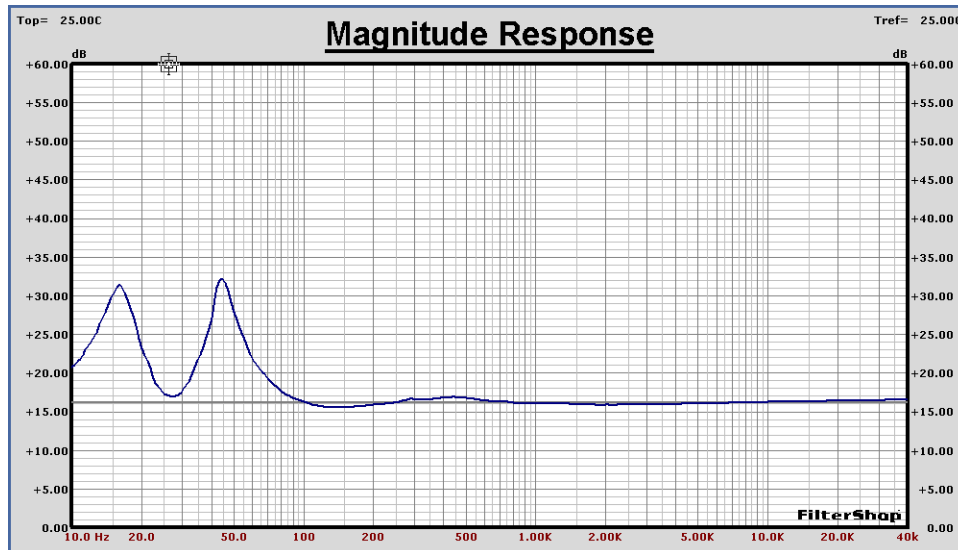
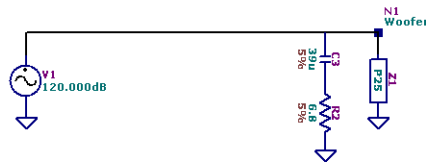

To compensate for the double resonance hump in the lower region, a double series - parallel RLC shunt network is required. This is shown below. For initial starting values, the inductors are given values of 10m Henries, the capacitors are assigned 1000u Farads, and the resistor set to 10 Ohms.

The Magnitude graph below shows the initial combined impedance of the circuit below. The compensation for the double hump is not yet optimal. As before the same objective flat line curve at 6.5 Ohms (Volts) is used, but this time the optimizer frequency range is from 10Hz to 150Hz. The previous RC values for the high frequency shunt are kept fixed and are not optimized.

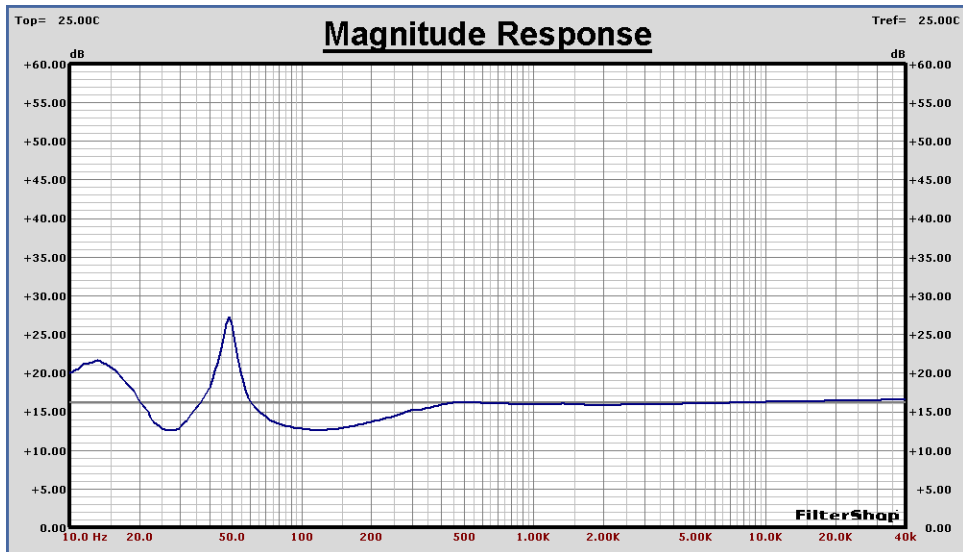
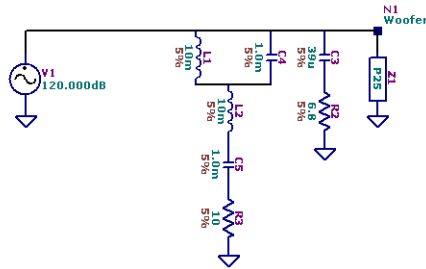

After the optimization of the double trap network, the results below were produced. The double hump is now greatly reduced. It is fair to assume that there is some interaction between the two shunt networks. Therefore, we should now optimize both shunts together across the entire frequency range. The results are shown on the following page.

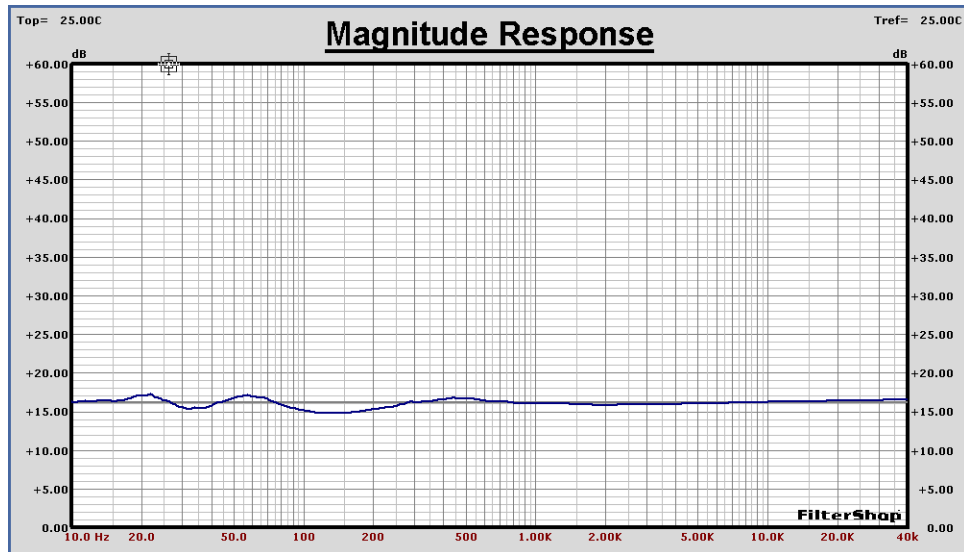
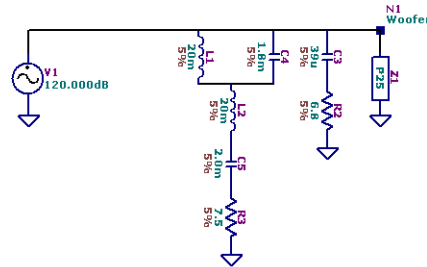

The resulting combined impedance is very flat. To achieve a flatter impedance the objective would need to be lowered. However, this would of course increase the power drawn from the amplifier, with the additional power being wasted in the network. There is a trade-off between the goal for flat impedance, and lowering of the overall impedance.

The double trap network uses 20m Henry inductors. These would be rather bulky and expensive, but can be readily obtained and/or constructed with iron or ferrite cores. The two capacitors are also large around 2000u Farads, but again this is to be expected for a network which must operate at very low frequencies.

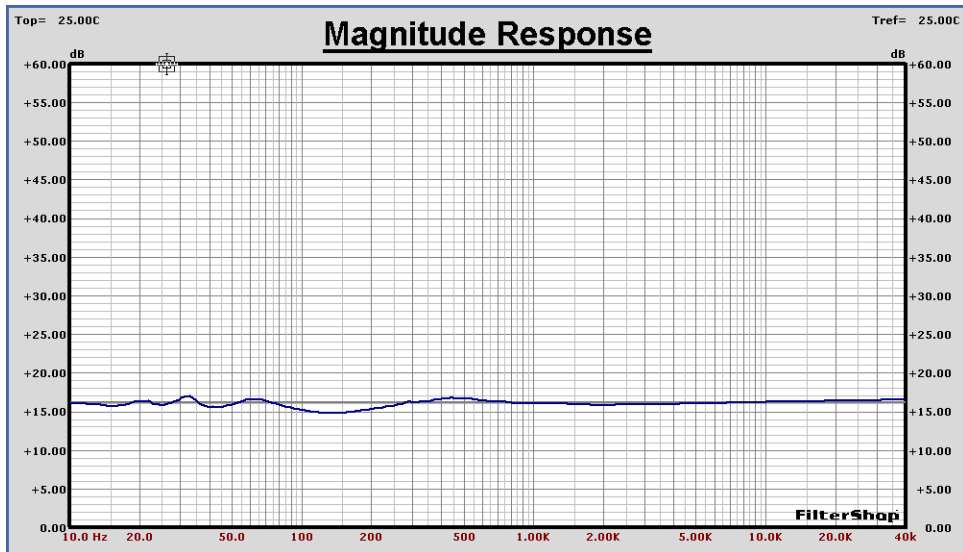
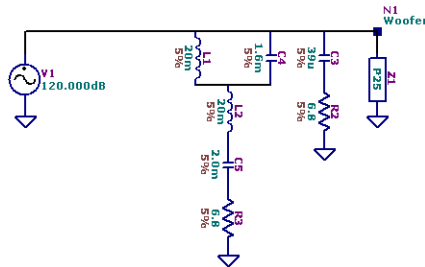

■ **Midrange Impedance Compensation**

The procedure for compensating the impedance reactance of the Midrange transducer is essentially the same as that previously used for the Woofer. However in this case the low frequency resonance is a single hump. To counter this impedance, a simple RLC series trap is used in addition to the usual high frequency RC shunt.

The objective for this transducer was reduced to about 6.0 Ohms, since its minimum impedance was slightly lower than that of the Woofer. After the network has been optimized the results are shown below.

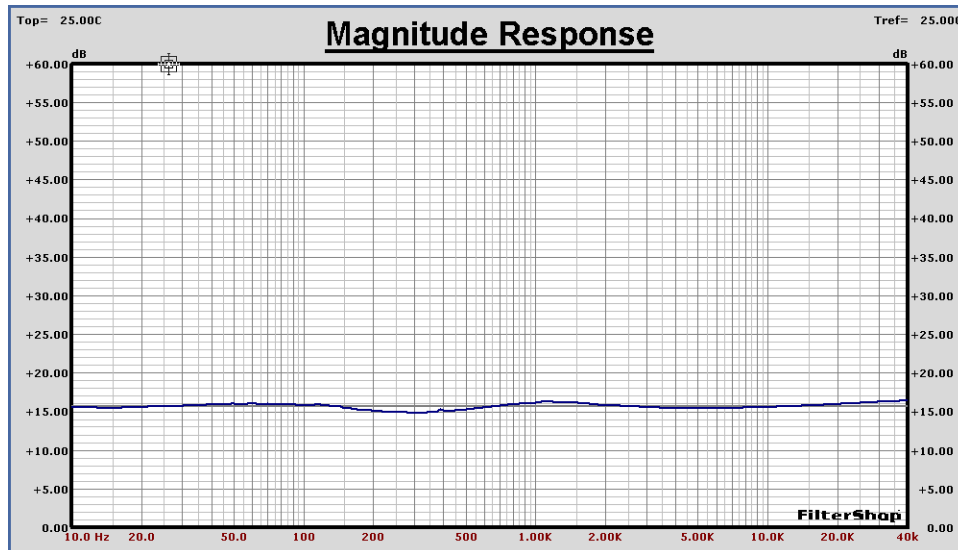
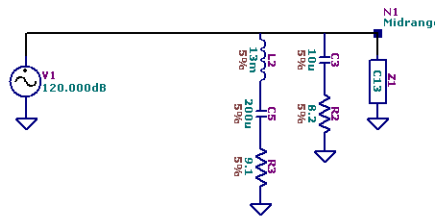

■ **Tweeter Impedance Compensation**

The procedure for compensating the impedance reactance of the Tweeter transducer is exactly the same as that previously used for the Midrange. The single RLC resonance trap is used in parallel with the RC high frequency shunt.

The objective for this transducer was reduced to about 4.5 Ohms, since its minimum impedance was lower than that of the Midrange. After the network has been optimized the results are shown below.

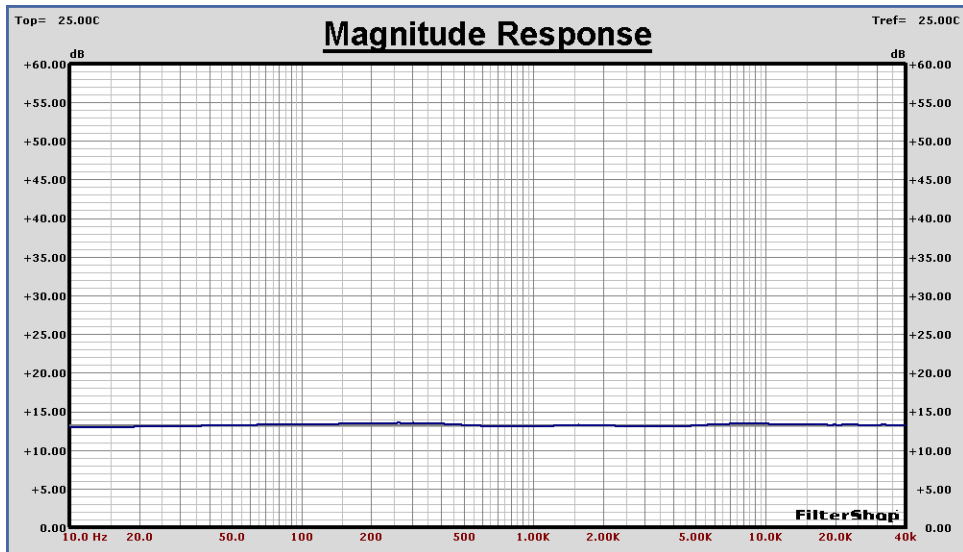
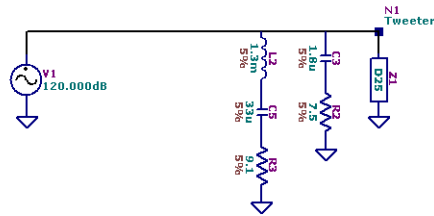

■ **Woofer Crossover Section**

The 4th order Lowpass section must now be designed. The corner frequency will be set to 200Hz, and the Butterworth 6dB Allpole family will be used as a target. This family has a response which is 6dB down at the corner, and even order LP/HP sections sum to a flat response. However, it is merely a starting point.

A new design file is started, and the synthesis circuit LP04_RLC_C is loaded. This is a single terminated form with only a load resistor. From our previous Woofer impedance optimization, we know that our load impedance is about 6.5 Ohms. Using that load impedance as a preset value for R1, running synthesis produces the following LP4 section.

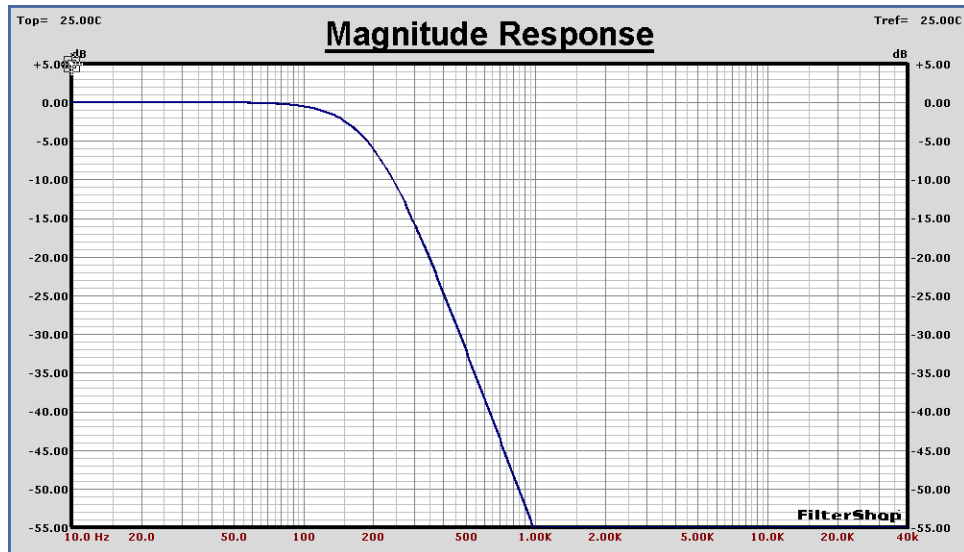
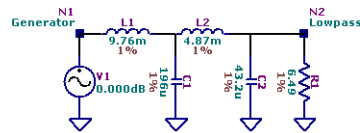

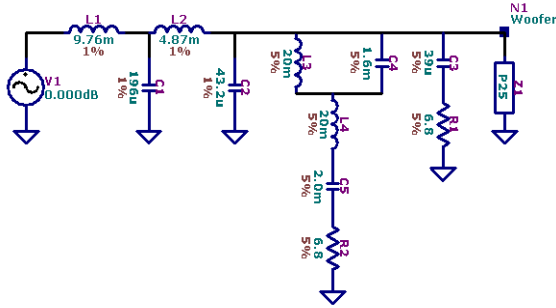

We can now change the circuit to custom, and import our previous Woofer impedance circuit as the real load for the section instead of R1.

The Magnitude response in the top graph below shows the ideal target and the actual circuit using the compensated transducer impedance as the load.

You might be curious to know what the response would have been without impedance compensation. By simply changing the two resistors R1 and R2 to high values, say 6.8M Ohms, we can observe the response with the raw Woofer as the load. This is shown in the lower graph.

Clearly the load impedance for a passive network directly affects the response. Without compensation, a peak of 9dB is produced.

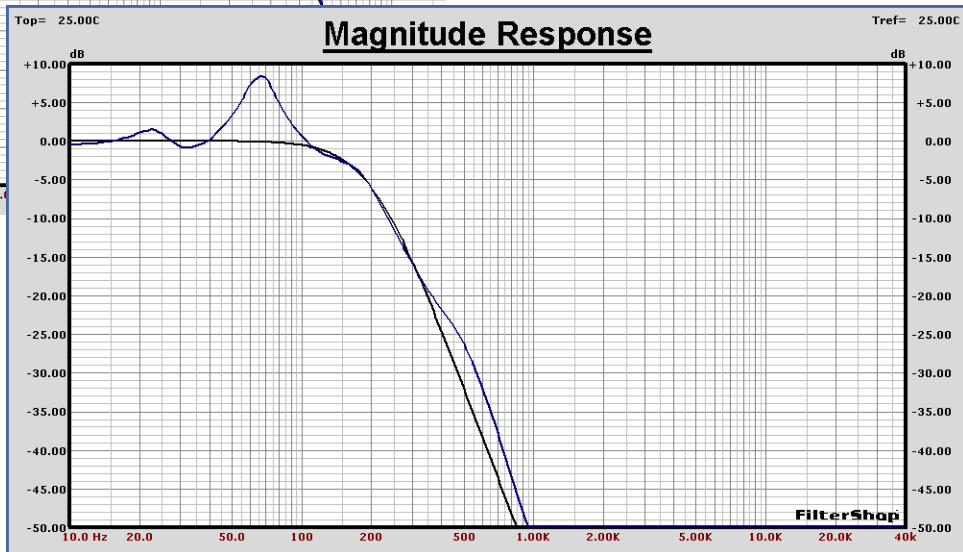
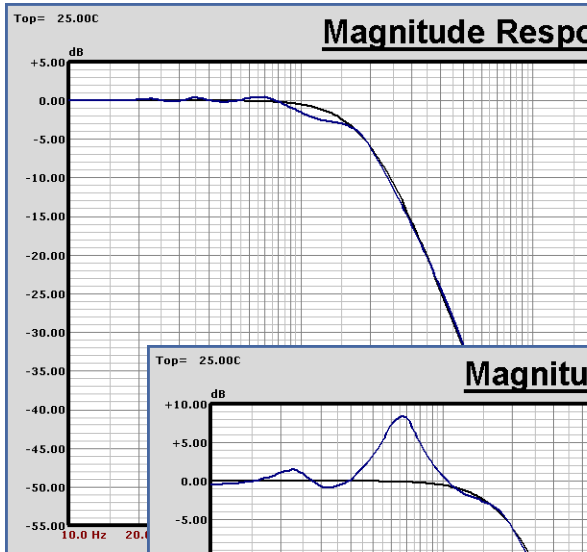

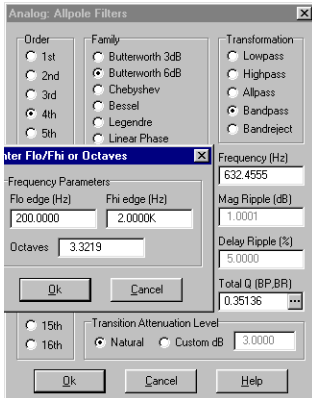

Midrange Crossover Section

The 4th order Bandpass section must now be designed. The corner frequencies will be 200Hz and 2000Hz, and again the Butterworth 6dB Allpole family will be used as the target.

Creating the Bandpass target can be easily handled by using the Flo/Fhi entry method for determining the required total Q and center frequency. This is shown on the left. Loading the BP04_RLC_C synthesis circuit, the initial network values were determined using the R1 preset load impedance of 6 Ohms. Then, with the Midrange transducer and compensation network substituted for R1, and the results are shown below. The response is pretty close to the ideal 4th order Bandpass target.

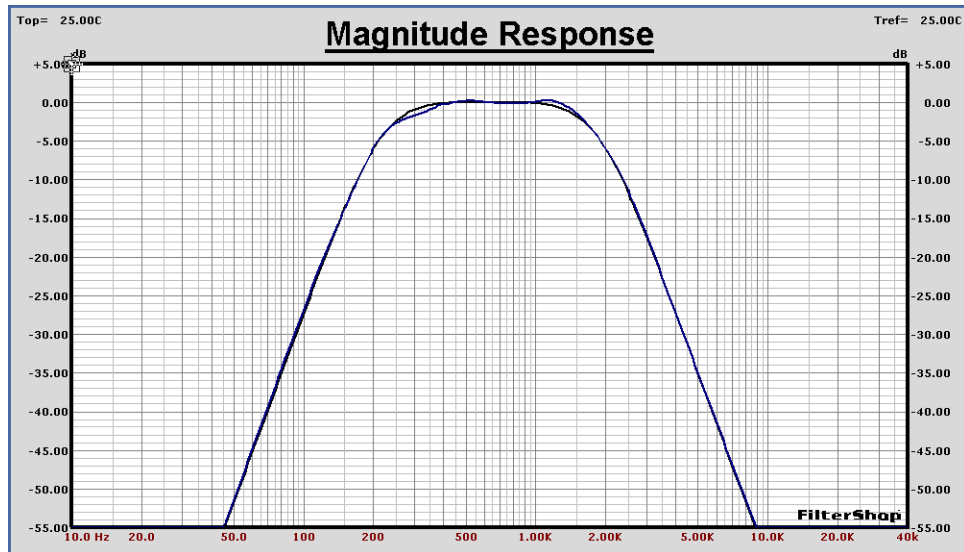
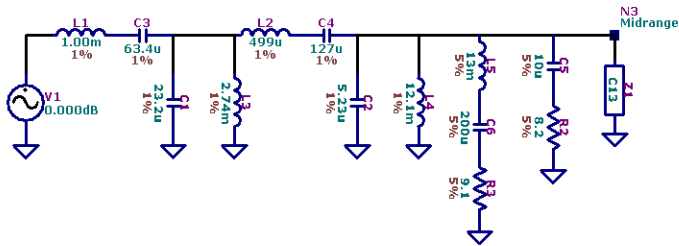

■ **Tweeter Crossover Section**

The 4th order Highpass section must now be designed. The corner frequency will be 2000Hz, and again the Butterworth 6dB Allpole family will be used.

After starting another design file, the HP04_RLC_C synthesis circuit is loaded, and the initial network values determined using the R1 preset load impedance of 4.5 Ohms. Then, with the Tweeter transducer and compensation network substituted for R1 , the results are shown below. The response is very close to the ideal 4th order Highpass target.

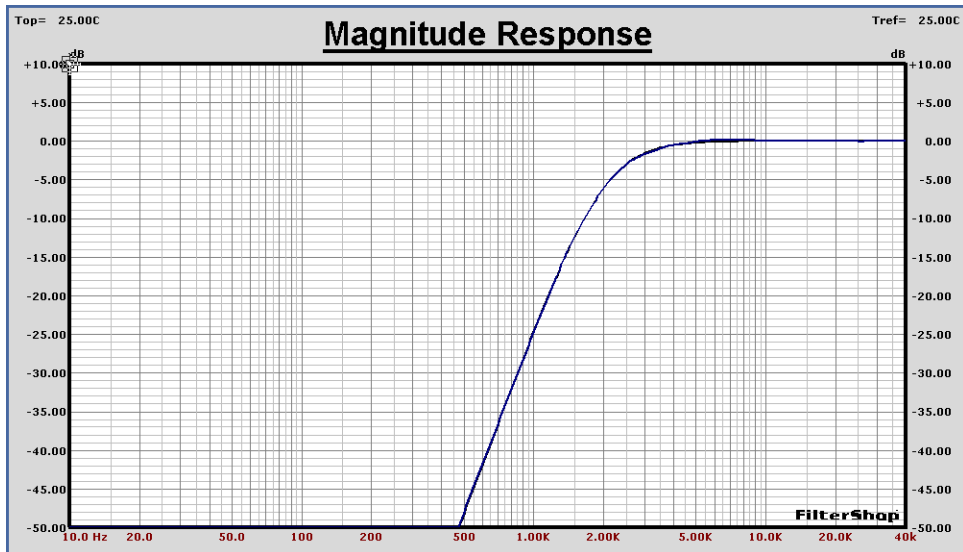
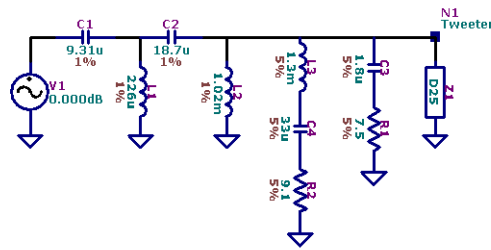

■ Adding the Transducer's Acoustic Response

We have now completed the electrical design of the passive networks, including compensation for the reactive impedance of the transducers. However, the transfer functions through the networks are only part of the solution. The acoustic response of the transducers themselves must also be included. As we shall see shortly, this will dramatically alter the previous network results.

Unless all of the transducers in a multiway acoustic system are coaxial mounted, an ideal crossover can only be designed for a single point in space. The drawing below illustrates the situation.

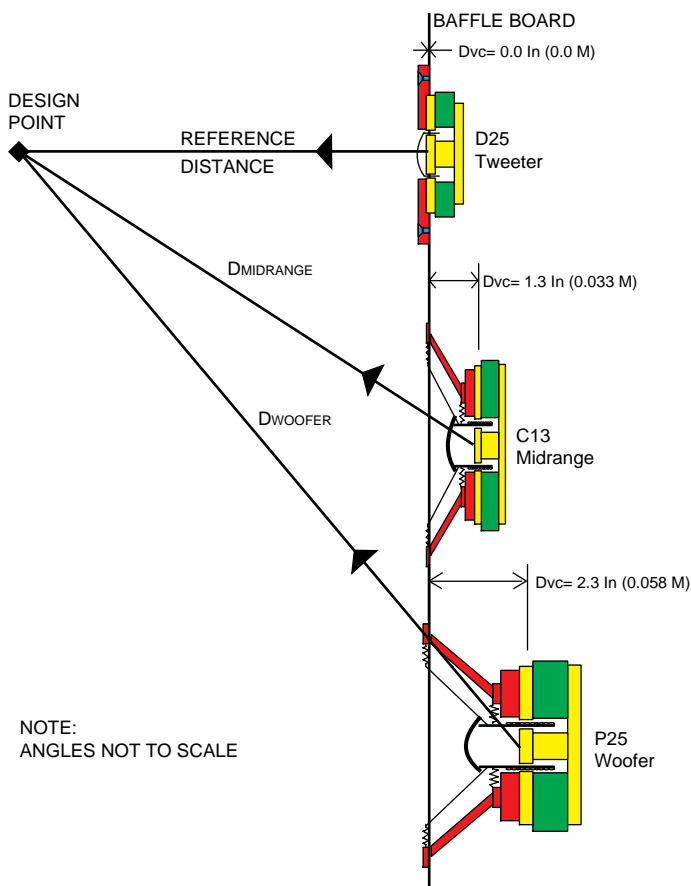

We know the acoustic response for each transducer, relative to their acoustic origins, but we must also determine any differences in delay.

At high frequencies, the acoustic origin of each transducer is very near the voice coil. This is where the conversion from electrical to acoustic wave propagation takes place.

The Tweeter is used as the reference since its voice coil is nearly in the plane of the baffle board. We will also assume the Design Point is on-axis with the Tweeter, and that the original SPL response for each driver was measured at the Design Point.

The voice coil of the Midrange driver is back set 0.033M and the Woofer is back set 0.058M.

However the total path difference between the drivers to the Design Point in space depends on the chosen reference distance, and the vertical spacing between the drivers.

At very far distance, the vertical driver spacing is relatively unimportant, and the path difference between the drivers becomes equal to the voice coil offsets. At closer distances the vertical driver spacing must be included in path computations.

Typical reference distances are usually given as either 1 or 2 Meters for most loudspeaker products. For this example we shall use 1 Meter as the reference distance. We shall also assume that the vertical spacing between each driver is about 6 Inches, or 0.15 Meters.

Using basic trig the acoustic path distances are:

$$\begin{aligned} D_{\text{TWEETER}} &= 1 \text{ Meter} \\ D_{\text{MIDRANGE}} &= \text{sqrt}((1+0.033)^2 + 0.15^2) = 1.044 \text{ Meter} \\ D_{\text{WOOFER}} &= \text{sqrt}((1+0.058)^2 + 0.30^2) = 1.100 \text{ Meter} \end{aligned}$$

Therefore the Midrange and Woofer path delay differences are:

$$\begin{aligned} \Delta D_{\text{MIDRANGE}} &= 0.044 \text{ Meter} & T_{\text{MIDRANGE}} &= 126\mu \text{ Sec} \\ \Delta D_{\text{WOOFER}} &= 0.100 \text{ Meter} & T_{\text{WOOFER}} &= 286\mu \text{ Sec} \end{aligned}$$

(Note: Speed of Sound constant 350M/Sec)

The Midrange acoustic response will be delayed by 126 μ Sec, and the Woofer will be delayed by 286 μ Sec.

Another set of design files is created for the Woofer, Midrange, and Tweeter, with the SPL response for each transducer imported into a Guide Curve. A transfer function component (H) will be appended to the signal path following the previous networks, and the SPL response Guide Curve is then loaded into the H component.

The H component has high input impedance and causes no change in the response of the network. The transfer functions of the SPL response and network response are simply multiplied together.

To represent the delay, a Buffer component (B) will be used. This component can produce both gain and delay. In our case we are only interested in the delay.

■ **Woofers Network with Acoustic Response**

The resulting network for the Woofer is shown below. It now includes the SPL response for the driver in H1, and the path delay in B1. A 1M Ohm dummy resistor is just used at the main output to provide two connections.

The Magnitude graph below shows the original SPL response of the Woofer, and the output from the network. The effect of the Lowpass network's transfer function can be clearly seen.

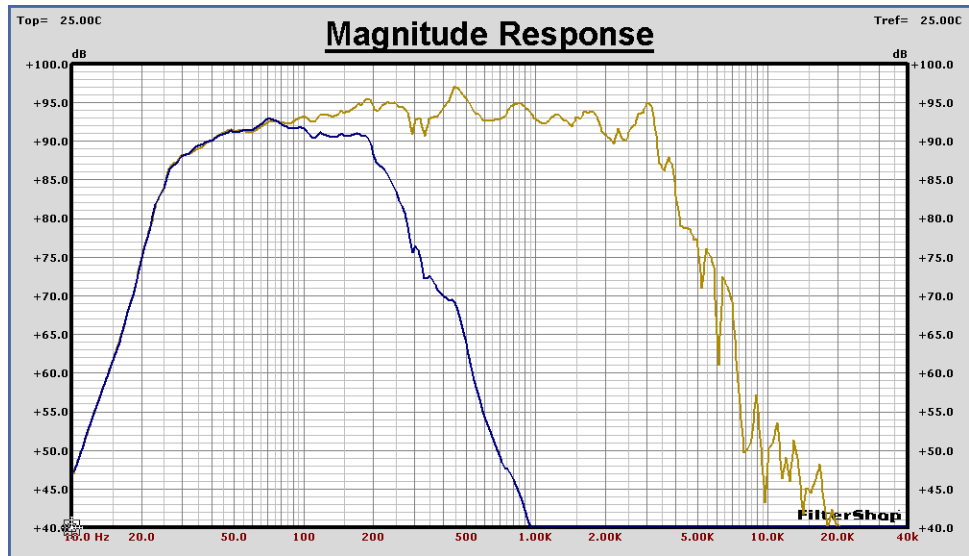
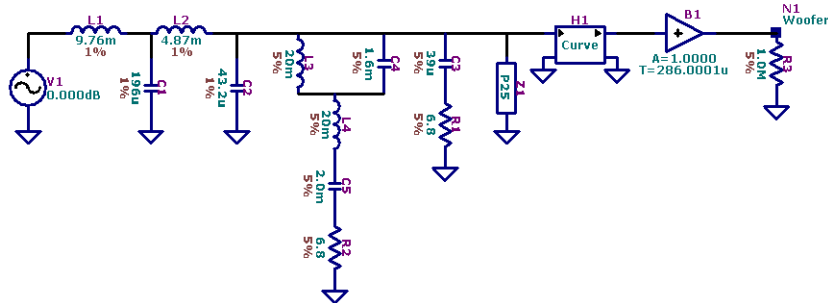

■ **Midrange Network with Acoustic Response**

The resulting network for the Midrange is shown below. It now includes the SPL response for the driver in H1, and the path delay in B1. A 1M Ohm dummy resistor is just used at the main output to provide two connections.

The Magnitude graph below shows the original SPL response of the Midrange, and the output from the network. The effect of the Bandpass network's transfer function can be clearly seen.

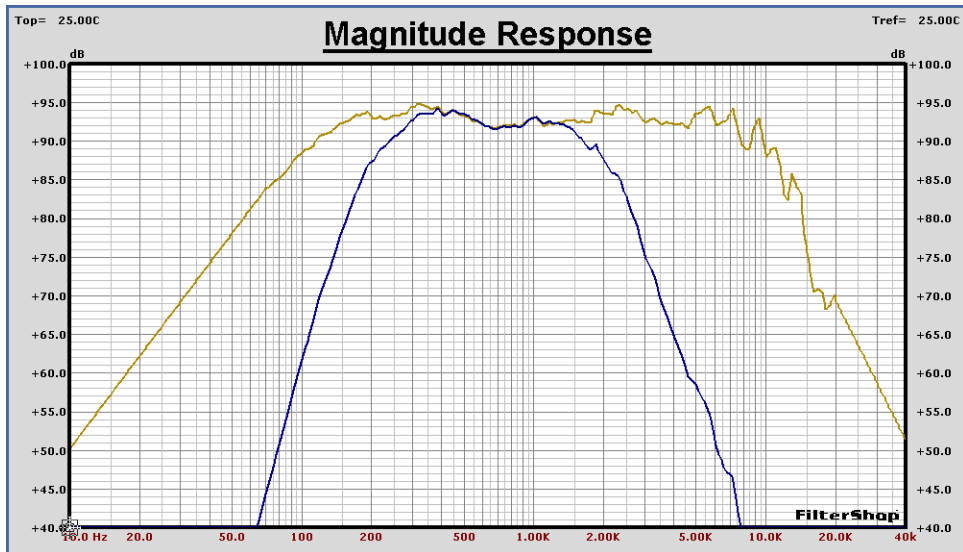
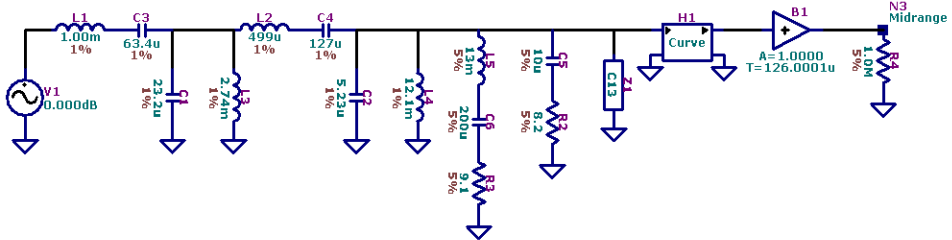

■ Tweeter Network with Acoustic Response

The resulting network for the Tweeter is shown below. It now includes the SPL response for the driver in H1. There is no extra delay for the Tweeter. A 1M Ohm dummy resistor is just used at the main output to provide two connections.

The Magnitude graph below shows the original SPL response of the Tweeter, and the output from the network. The effect of the Highpass network's transfer function can be clearly seen.

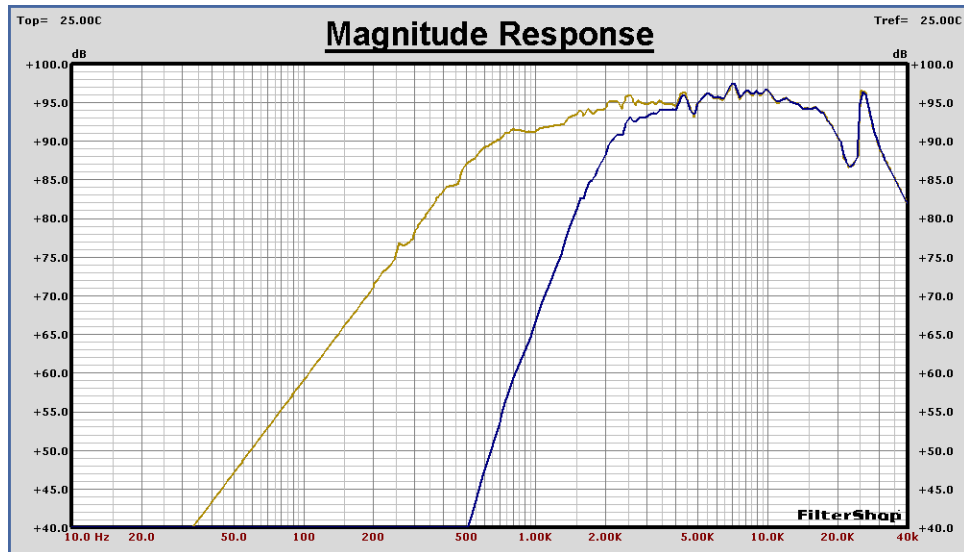
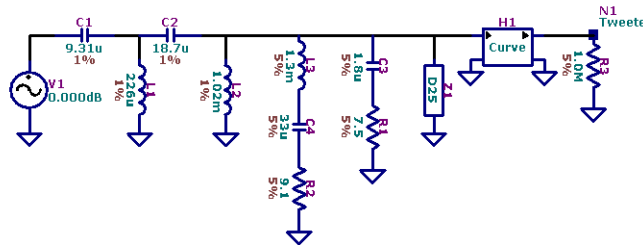

■ Woofer Optimization

We could now attempt to sum all three sections together and optimize the overall system response. However with the newly added acoustic responses, the base level of each section is not identical. Each driver has different sensitivity and the non-ideal response shapes of each driver directly effect the total response from each section.

We must first choose a base level for the entire design. Looking at the previous response curves, the Midrange and Tweeter both have higher output then the Woofer. Since a passive network cannot raise the level, we must design around the lowest which is the Woofer. A base level of 92dB will be selected for the design.

The offset level of the Target is now raised from 0dB to 92dB. The Target Data Curve is then copied to a Guide Curve for use as the optimization objective.

Only four components will be optimized, the Lowpass filter components C1, C2, L1, L2. The optimizer frequency range will be about 60Hz to 700Hz, which is the range where these components will be effective. The conjugate impedance compensation components will be kept fixed.

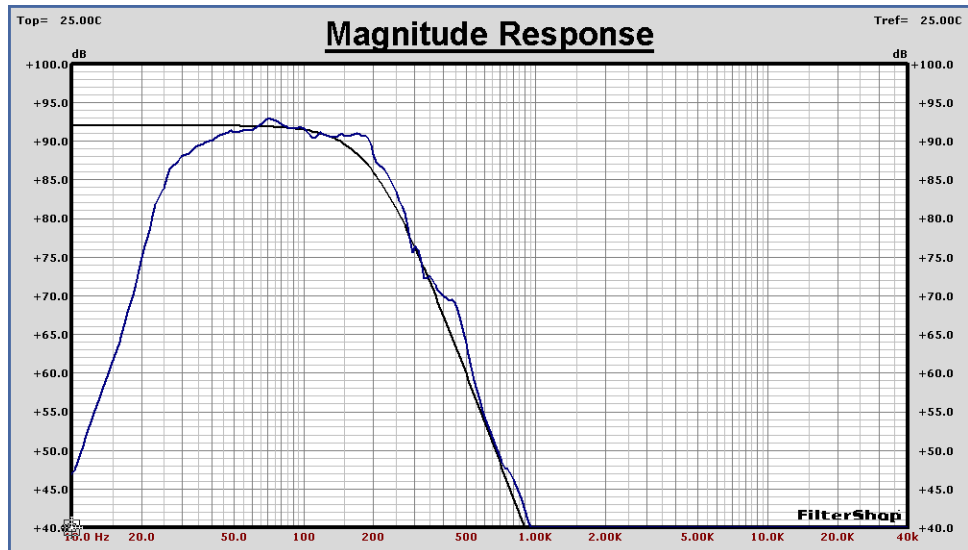

After optimization, the results are shown below. The response now maintains a much tighter control around the ideal Lowpass objective. The ripples in the Woofer's acoustic response limit the ability of the network to perfectly match the ideally smooth objective curve.

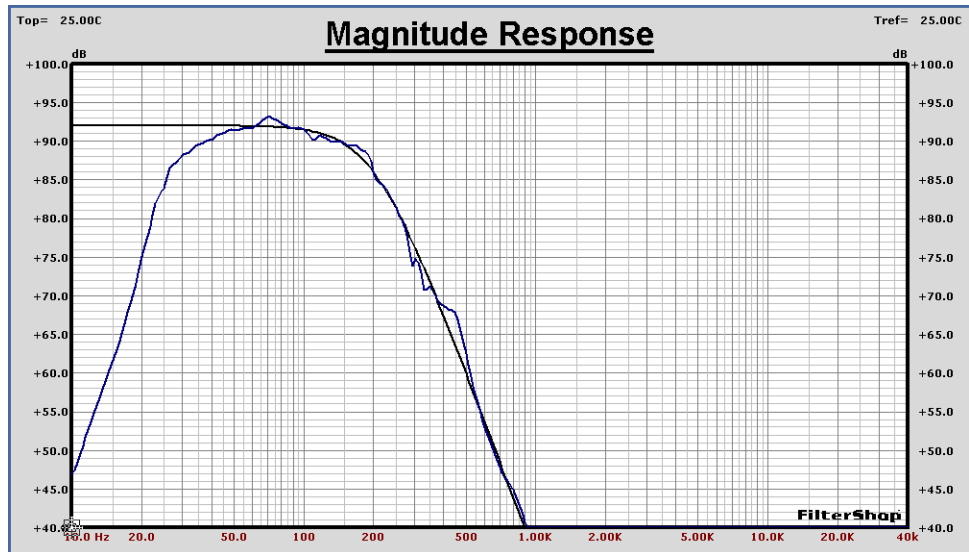
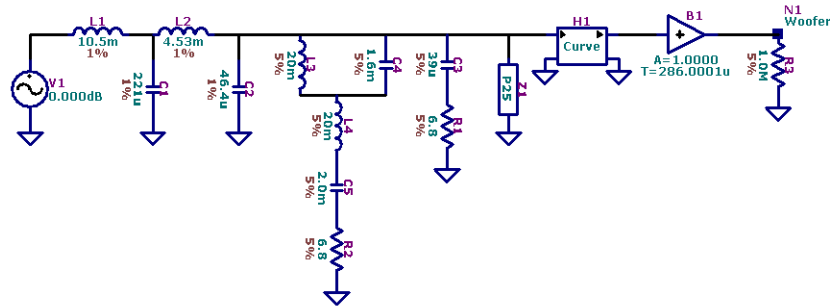

■ Midrange Optimization

As with the previous optimization, the Bandpass Target level is raised to 92dB. The existing response of the circuit and the ideal target is shown below. The slope of the lower side is actually greater than that of the target. Also, the level in the passband region seems to be slightly higher on average as compared to the target.

It is probably fair to assume that some padding will be required to reduce the overall level to the 92dB base. We will add a new resistor between the filter and conjugate compensation sections of the network. The initial value will be 1 Ohm.

The frequency range for optimization will be 60Hz to 7kHz. This covers enough of the tails on each side to define the proper order of the Bandpass response.

Because the passband region is small percentage of the total frequency range from 60Hz - 7kHz, Peak Error optimization will be used. This ensures that the passband region is given as much importance as the tails.

Nine components were selected for optimization: C1-C4, L1-L4, and the pad resistor R5. The LC values pertain to the Bandpass section of the network.

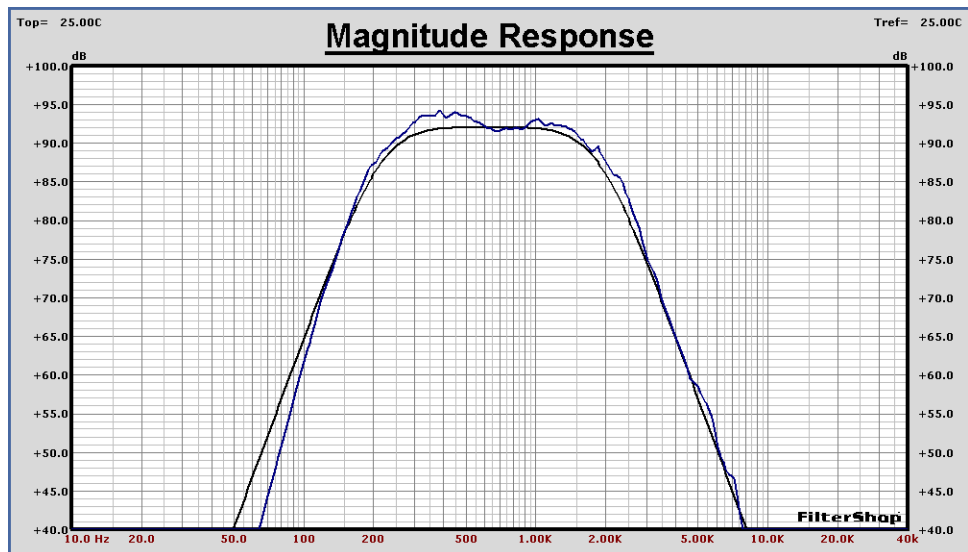

After the optimization is completed, the results below were produced. The response is now fairly close to the target, but some broad ripple remains across the top in the passband region. It is probably best to wait until we see what the final system response turns out to be, rather than addressing a problem now which may not exist when all of the three sections are summed.

Examining the changes to the nine components, we note that inductor L4 is now 73m Henry. This is a large value and produces a high impedance. In effect the optimizer is informing us that this component is not needed. With this component removed from the circuit, and the circuit recalculated, the response is indeed unchanged. The new pad resistor was optimized to 0.68 Ohms. Only a small amount of padding was required.

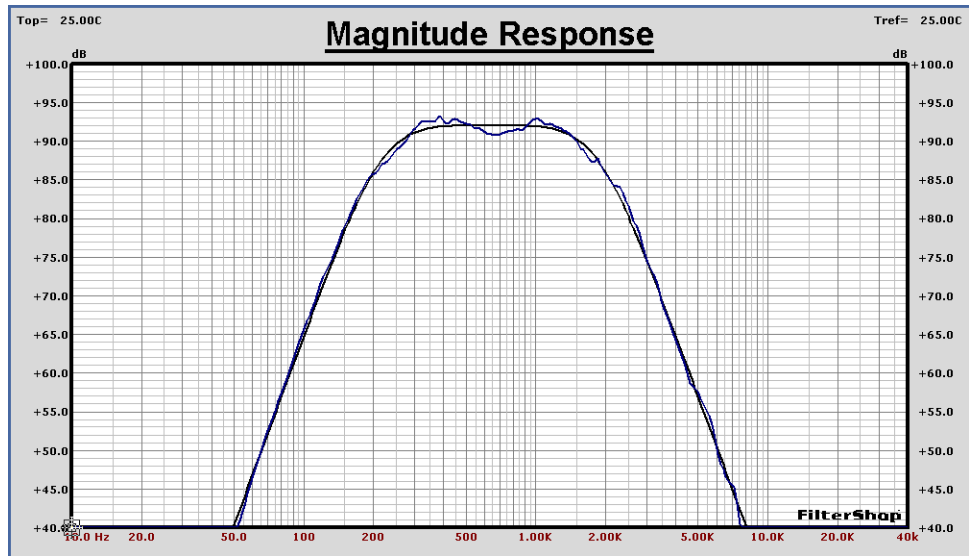
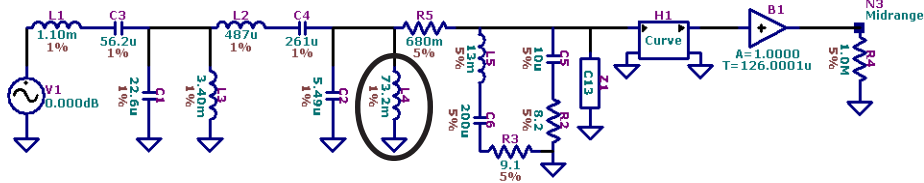

■ Tweeter Optimization

As with the previous optimization, the Highpass Target level is raised to 92dB. The existing response of the circuit and the ideal target is shown below. The slope of the Highpass is actually greater than that of the target. Also, the level in the passband region is substantially higher as compared to the target.

The Tweeter will certainly require padding. Also note that the high frequency response of the Tweeter above 10kHz is slightly rolling off until the dome resonance is reached at 25kHz.

Since a padding resistor will be used, we can shunt the resistor with a capacitor and obtain some high frequency boost. This will flatten the response of the tweeter to higher frequencies.

The new pad resistor and cap will again be added between the Highpass section and the conjugate compensation section. The optimizer frequency range was setup as 500Hz to 17kHz. Six components were optimized: C1, C2, L1, L2, and the new R4, C5.

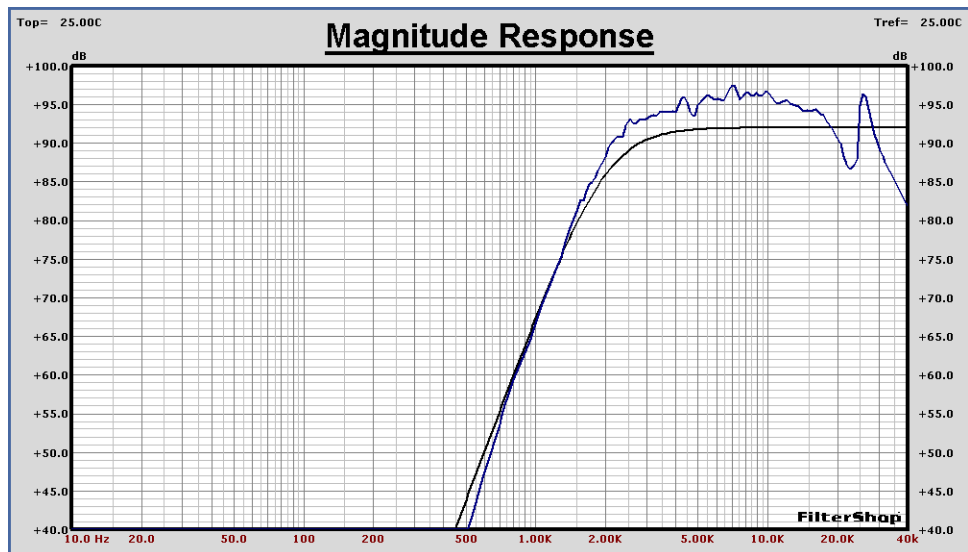

After the optimization is completed, the results below were produced. The response is now very close to the target, with a -3dB point at 20kHz.

The pad resistor R4 was optimized to 2.4 Ohms, and the shunt boost cap to 5.1u Farads.

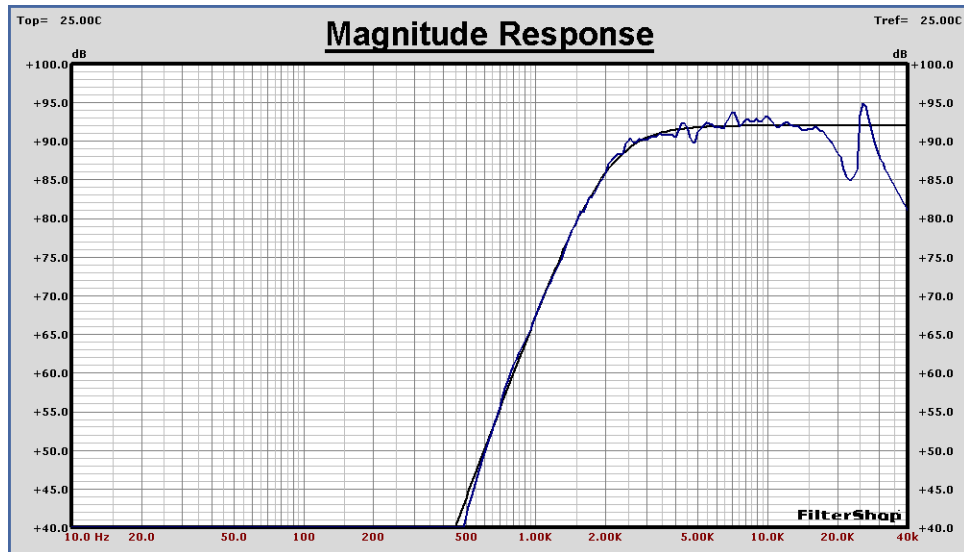
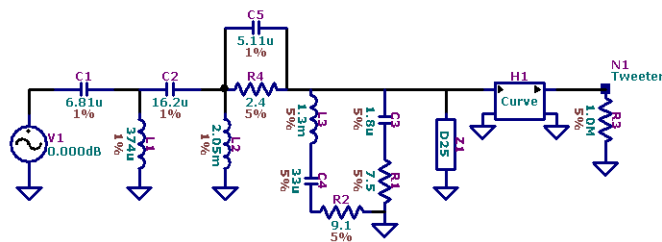

System Response Optimization

We are now ready to simulate the total system response. A new design file is opened and all three of the previous circuits are imported. The inputs are paralleled to use a common single generator, with the two extra generators removed.

A summer component is added to sum the outputs of the Woofer, Midrange, and Tweeter networks. Two new Data Nodes were added, one for the main system output, and the other at the generator. The Data Node at the generator will be used later to observe the final system input impedance. The new system circuit model is shown below.

Initially all of the outputs will be summed inphase. The first graph on the following page displays the response for each output as well as the system output. The lower crossover point at 200Hz between the Woofer-Midrange has filled in nicely. However the higher crossover point at 2kHz between the Midrange-Tweeter shows a significant dip.

The obvious conclusion would be that the Tweeter polarity must be reversed. By changing the polarity on the top input of the Summer component, the response in the lower graph is produced. In the actual enclosure we would reverse the wiring to the tweeter. The crossover region at 2kHz is now correct.

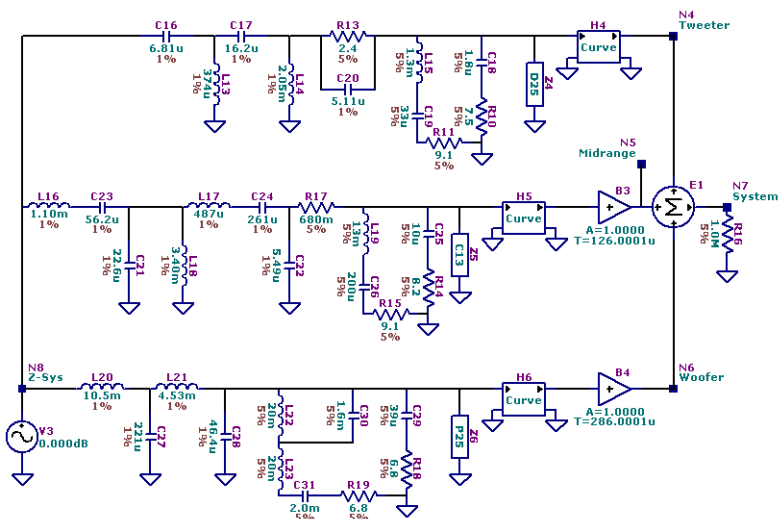

System Response: All Outputs In-Phase

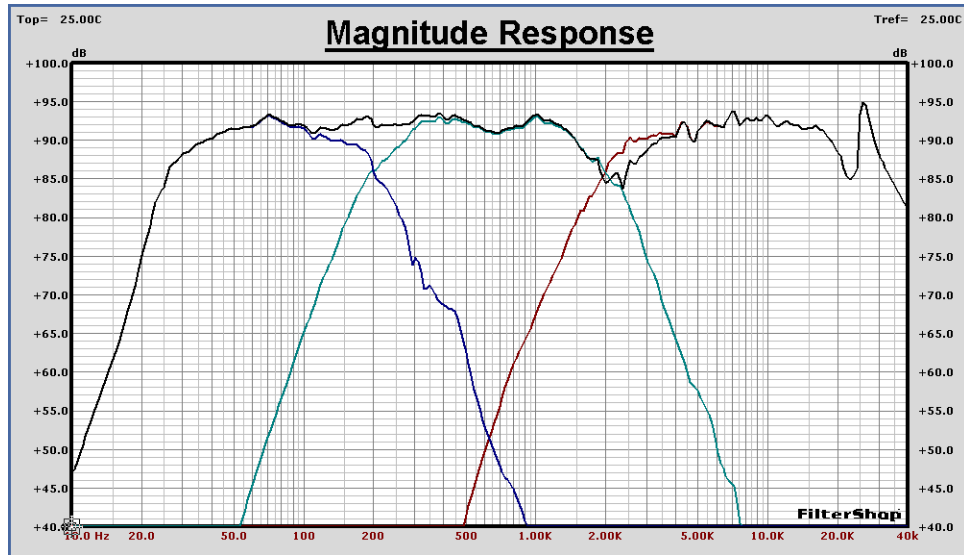

System Response: Tweeter Polarity Reversed

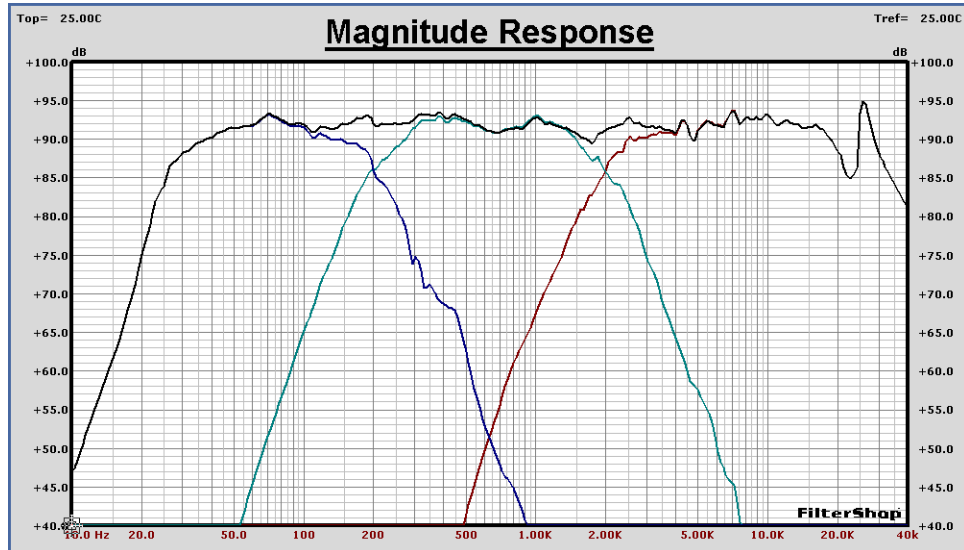

We now examine only the main system output as compared to a flat line Target of 92dB. This is shown below. The response is approximately -3dB @ 30Hz and 20kHz. The response maintains a tolerance of ± 2 dB across the entire spectrum.

By previously optimizing the individual sections alone, the summed response is already very good. There is little room for improvement, however the dip at the 2kHz crossover region can be somewhat reduced.

To flatten the upper crossover point, we could elect to reoptimize the tweeter network, or the Midrange network. In this case the Midrange network was chosen, and a frequency range of 100Hz to 4kHz was setup.

Eight components were optimized: L16-L18, C21-C24, and R17. These represent the Bandpass network and padding resistor.

The final circuit is shown on the following page, along with the final system Magnitude response. The flatness is now very near ± 1 dB.

By changing the generator output to 120dB, and its impedance to 1M Ohm, the system impedance can be observed at the generator terminal. This is shown in the Magnitude and Amplitude graphs on a following page.

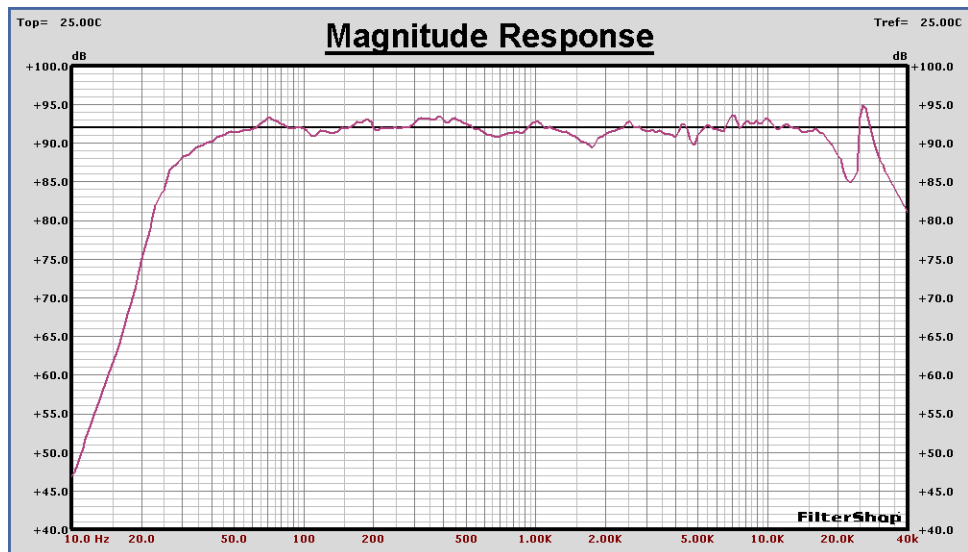

Final Crossover Network and System Response

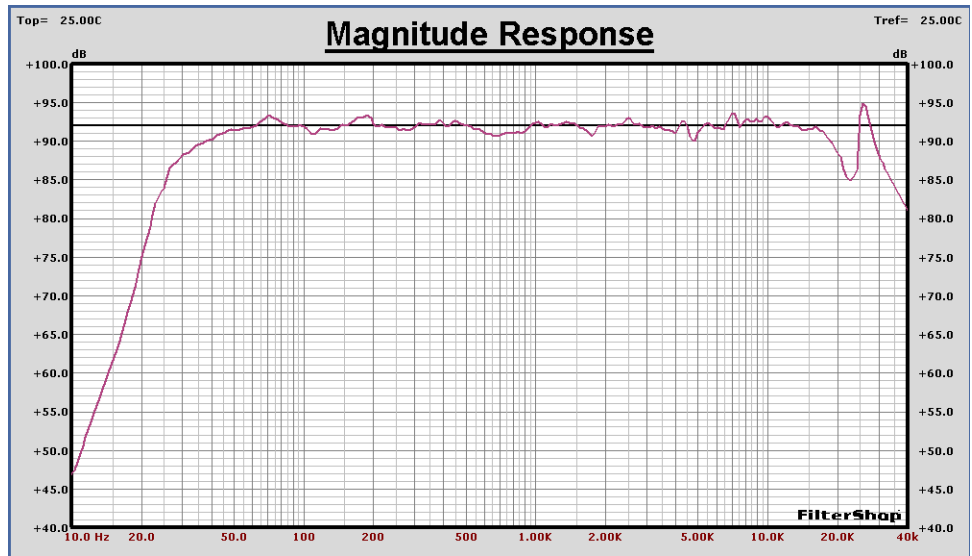
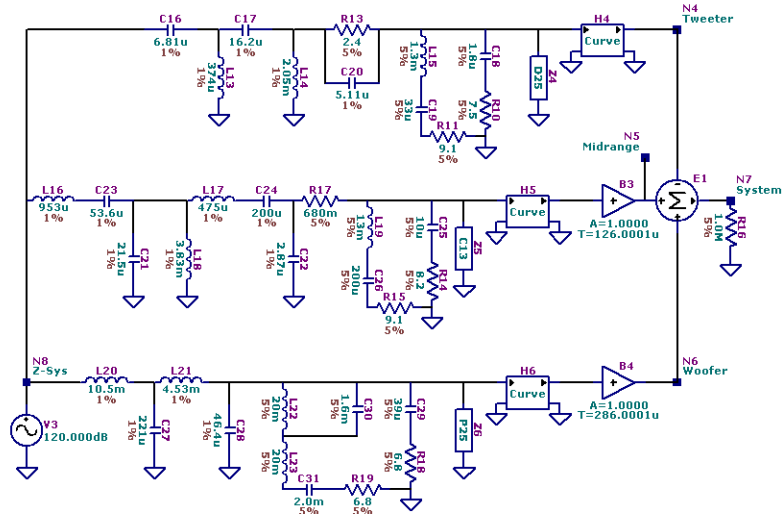

System Input Impedance, dB Ohms and Linear Ohms

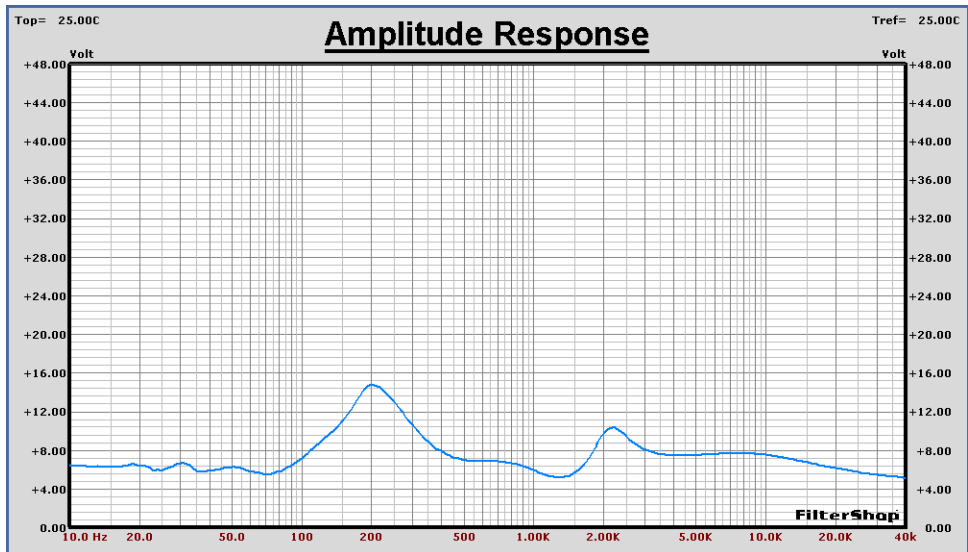
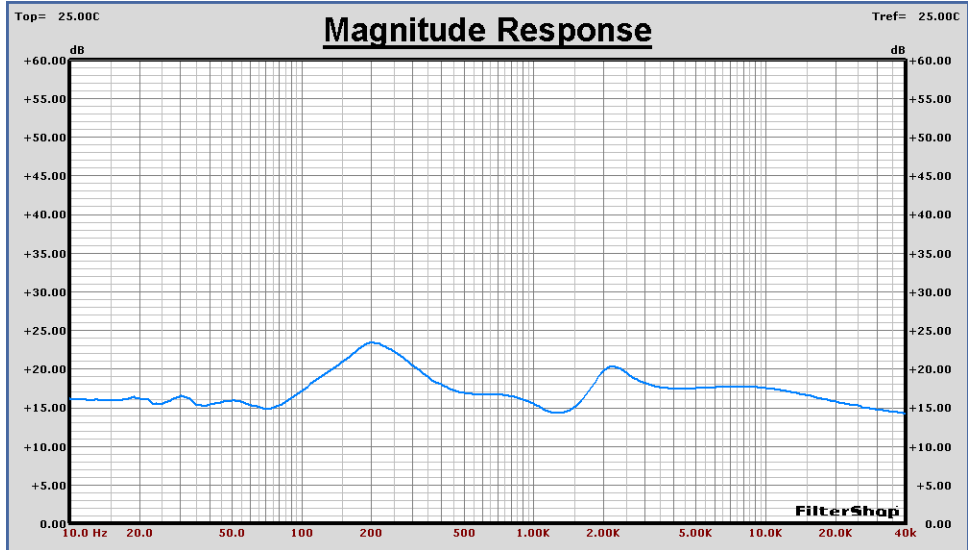

■ Summary

This passive crossover design was relatively complex, and utilized 35 components. The purpose was to demonstrate optimization techniques for both impedance compensation as well as system response. It also showed a method of importing the SPL response and actual impedance of each transducer within the network.

The issue of inductor loss was not covered, but can be easily included if specific information is known about the inductors to be used.

Typically the cost of a passive crossover is equal to or greater than the cost of the transducers in the enclosure. Depending on the performance/cost requirements, many of the components in this example could have been eliminated for a more practical production design.

This completes the Analog Audio Passive Crossover Design.